

一.尺寸图/DIMENSION (单位/UNIT : mm)

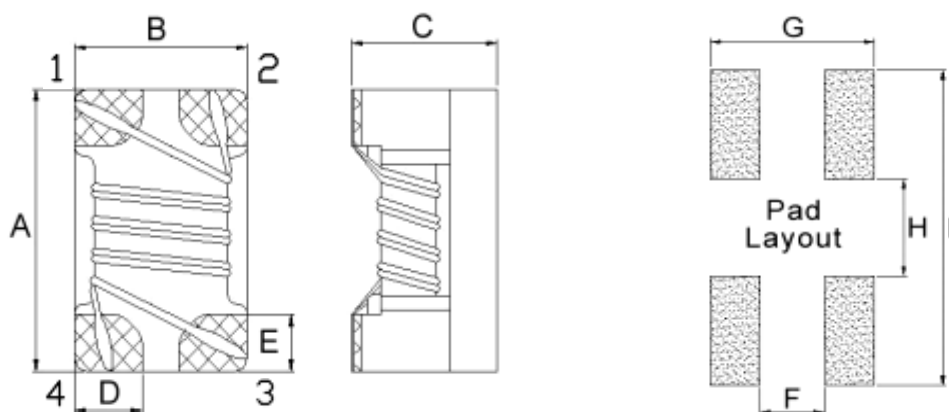

ITEM	A	B	C	D	E	F	G	H	I
DIM	3.2	2.5	2.2	0.9	0.8	0.6	3.5	1.6	4.4
TOLE	±0.2	±0.2	±0.2	Typ	Typ	Typ	Typ	Typ	Typ

二.电路图/SCHEMATIC

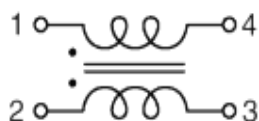

三.注意事项/NOTE :

- 1.产品不印字
- 2.崩缺面积直径小于0.3mm为允收

四.电气特性/ELECTRICAL CHARACTERISTIC

Part Number	Common mode Impedance (Ω @100MHz)	DC Resistance (Ω) Max.	Rated Current (mA)Max.	Rated Volt. (Vdc)Max.	IR (Ω) min.
GCM-3225SF-900	90 ±25%	0.10	1000	50	10M
GCM-3225SF-601	600 ±25%	0.20	1000	50	10M
GCM-3225SF-102	1000 ±25%	0.30	400	50	10M

- (1).Rated Current: Temp.rise 40°C Typ
- (2).Operating Temperature: -40°C up to +125°C
- (3).Storage Temperature: -20°C up to +40°C, 75% RH max.

五.特征曲线/CHARACTERISTICS(REFERENCE)

GCM-3225SF-900

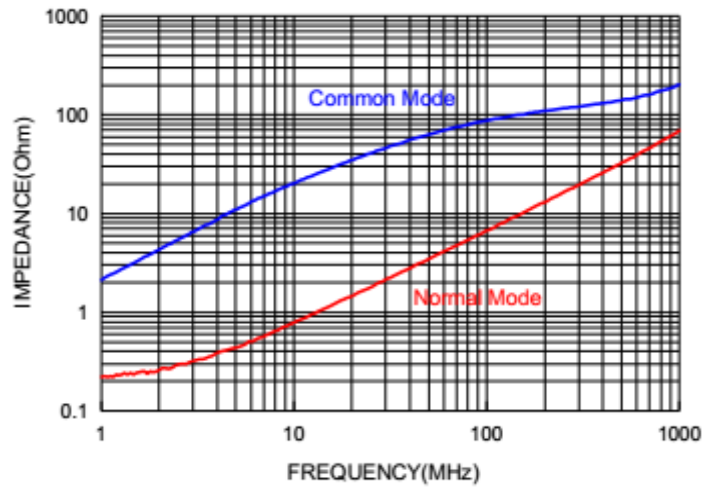

GCM-3225SF-601

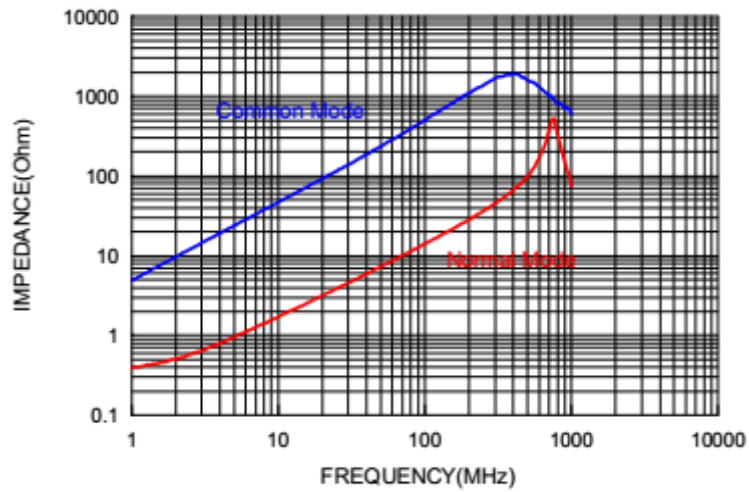

GCM-3225SF-102

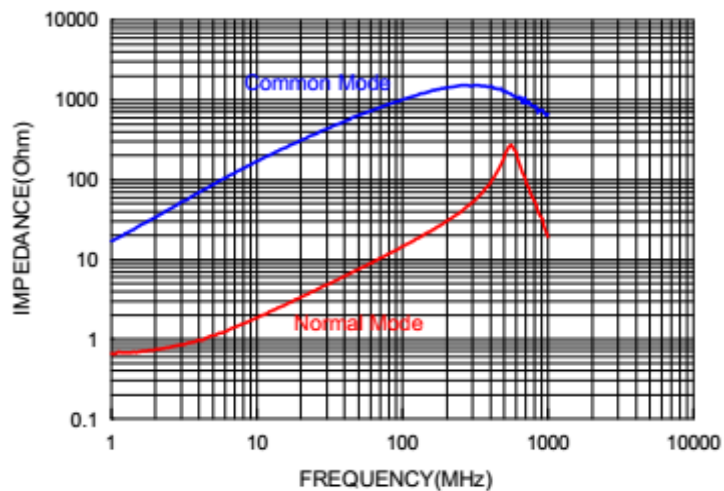

六.可靠性测试/RELIABILITY TESTING

Operating Temperature	- 40 to +125 °C (Contain Heating coil)
Appearance Inspection	No external defects by visual inspection
Terminal Strength	After soldering , between copper plaet and terminals of coils , push in two directions of X , Y with standing 10N(1.02kg) for10+/-2 sec. Terminal should not peel off. (Refer to figure at right)
Heat endurance of reflow soldering	Refer to figure
Insulating resistance	Over 100 MΩ at 100V D.C . between wire and core
Dielectric Strength	Apply at 0.5KV 3mA for 1 minute between wire and core
Temperature characteristics	Inductance coefficient (0~2,000) × 10 / °C (- 40~ + 125 °C)
Humidity characteristics	Inductance deviation within ± 10% , after 96 hours in 90~95% relative humidity at 40 ± 2 °C and 1 hours drying under normal condition

A test is made under the above mentioned condition , and it is kept for 2 hours in the normal

IR Reflow profile

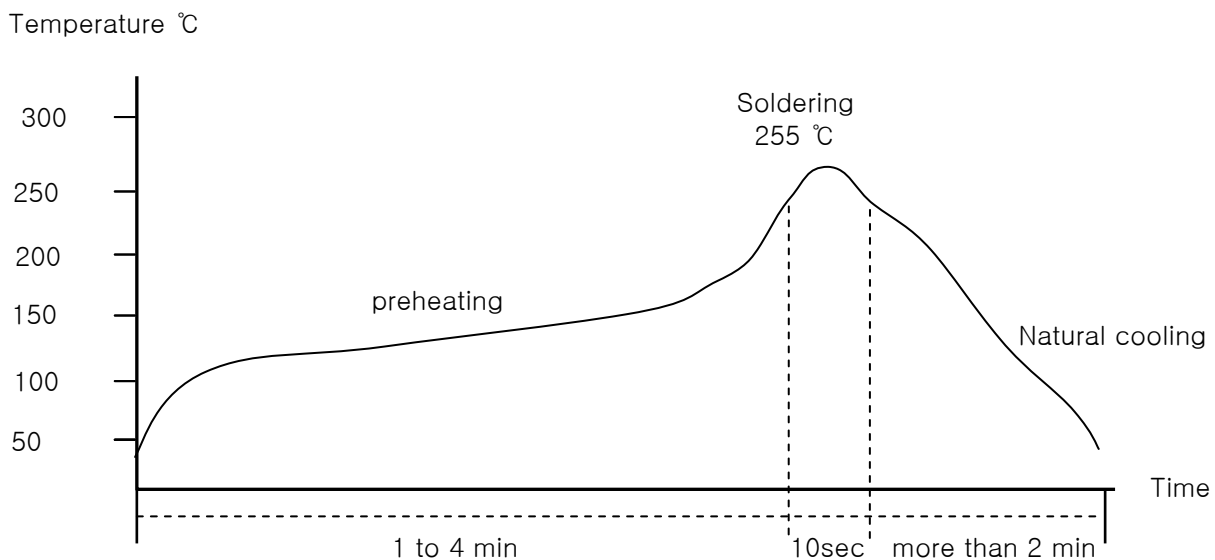

Temperature and humidity . After that , no mechanical and electrical defect should be found .

七.材料清单/MATERIAL LIST

NO.	ITEM	DESCRIPTION
1	CORE	FERRITE
2	WIRE	P180 G1
3	ADHESIVE	5890LC
4	TIN	107H

八.包装规格/PACKING SPECIFICATIONS

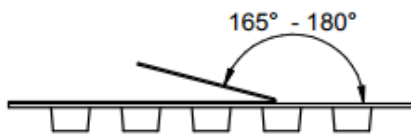
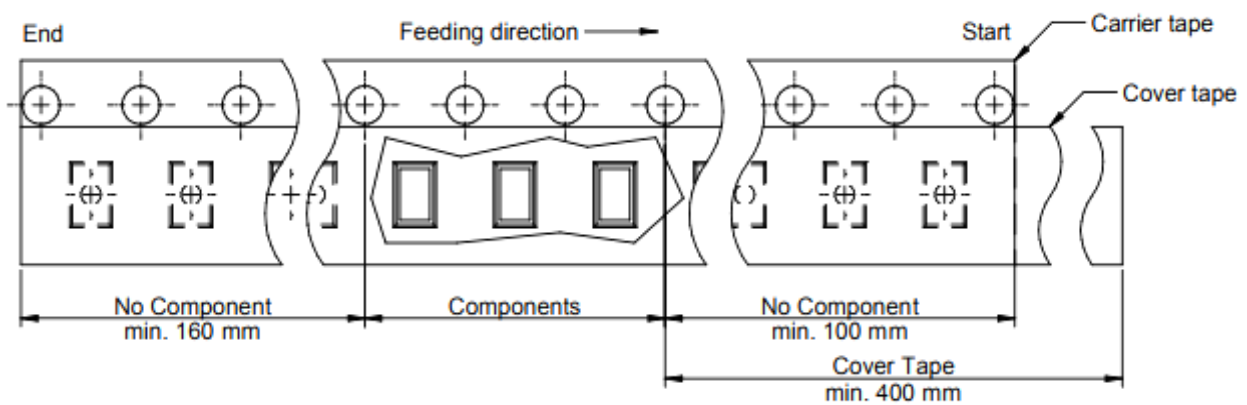

Tape width	Distance	Pull-of force
8 mm	4 mm	10~120g



轮盘：7'(直径178mm)
数量：2000PCS/盘

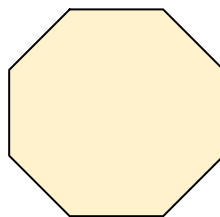

内盒/PE袋
数量：8000PCS/盒

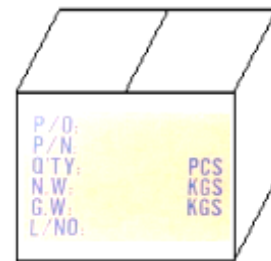

外箱，数量：80000PCS/箱
不足整箱用内盒或填充物装满